



JOHNSTONE SUPPLY



Your HVACR Source

Tools & Test Instruments

21-Pocket Tool Pouch



*Tools pictured not included

24⁹⁹

H26-604
Mfg. #1509



Digital Manifold



349⁰⁰

H85-601
Mfg. #SMAN3



Oxy-Acetylene Brazing Kit



299⁹⁹

H85-401
Mfg. #CST-CPT



Supernova Digital Vacuum Gauge



179⁹⁹

H27-110
Mfg. #DV-41



G2 Phoenix Clamp Meter



99⁹⁹

H26-493
Mfg. #DL379



11-in-1 Screwdriver/Nut Driver



14⁹⁹

H27-026
Mfg. #32527



R22/R404A/R410A Manifold



84⁹⁹

H26-424
Mfg. #42004



Prices Valid Through May 31, 2013 at Participating Johnstone Supply Stores

New **Ti125**
Thermal Imager

FLUKE®

- 3.5" display with 160 x 120 pixel resolution
- IR-Fusion® technology combines visible image with IR image for easy identification
- AutoBlend™ mode aligns digital and infrared images in a single view
- Multi-mode video recording will record focus-free video in visible light and infrared with full IR-Fusion capabilities
- IR-PhotoNotes™ annotation system captures up to three digital photos to add images such as equipment and motor nameplates
- Thermal sensitivity: 0.08°C @ 30°C
- Includes AC power supply, 2 bay charging base, SD memory card, USB memory card viewer SmartView™ software, hard carrying case, soft transport bag and hand strap



5,495⁰⁰

H85-708
Mfg. #Ti125

New **Visual IR**
Thermometer

FLUKE®

- Detect issues instantaneously through combined visual and infrared image
- Quickly find hot and cold spots with visual, infrared and blended views
- Easily read temperature measurement at center point
- Document problems with SmartView software (included)
- Images stored on micro SD card for easy download to PC
- Includes 4 AA batteries, micro SD card, micro SD to standard SD card adapter, lanyard, and hard case



895⁰⁰

H27-502
Mfg. #VT02

CNX 3000 SERIES WIRELESS MULTIMETER AND EXPANSION MODULES

New

- Save time and money by taking multiple measurements simultaneously
- Displays readings from the meter and up to three wireless modules up to 65' feet away, view up to 10 live readings on a PC
- Captures up to 65,000 sets of MIN/MAX/AVG time-stamped readings over single or multiple logging sessions
- Increases safety by taking readings in a separate location from the point of measurement
- H85-725 includes multimeter, AC current clamp module, temperature module and accessories



Order #	Mfg. #	Description	Price
H27-520	CNX 3000	Wireless Multimeter	349.95
H27-521	CNX i3000	Wireless iFlex Current Module	199.95
H27-522	CNX A3000	Wireless Current Clamp	169.95
H27-523	CNX V3000	Wireless Voltage Module	169.95
H27-524	CNX T3000	Wireless K-Type Temperature Module	169.95
H85-725	CNX 3000 HVAC	CNX Wireless HVAC System	599.95

FLUKE®

UTL Series Clamp Meter

- Backlit display
- Measures AC/DC voltage, AC current, resistance and continuity
- Includes batteries and test leads

29⁹⁹

H26-156
Mfg. #UTL260



UTL Series Multimeter

- Large display, positive grip rubber boot with tilt stand
- Measures AC/DC voltage, DC current, temperature and resistance
- Includes test leads, K-type temperature probe, boot and 9V battery

11⁹⁹

H26-073
Mfg. #UTL33T



Dual Range Non-Contact Voltage Tester

- Automatically detects low and high voltage (12-1000VAC)
- Auto power-off

14⁹⁹

H27-154
Mfg. #NCVT-2



Temperature/Humidity USB Data Logger

- Logs 32,000 data points (16,000 temperature and 16,000 relative humidity)
- Includes analysis software

69⁹⁹

H26-772
Mfg. #THL2



Stick Meter

- Designed for one-handed testing
- Built-in non-contact voltage sensor
- Measures temperature up to 200°F
- Connects to Fieldpiece accessory heads

114⁹⁹

H26-143
Mfg. #HS33



New Wireless Swivel Head Clamp Meter

- Receives wireless measurements from any Fieldpiece accessory head connected to a Fieldpiece wireless transmitter
- 180° swivel-head allows for easy viewing at any angle
- Connects to Fieldpiece accessory heads

199⁹⁹

H27-416
Mfg. #SC57



Clamp Meter

- Manual or autoranging
- Measures temperature up to 1000°F
- Connects to Fieldpiece accessory heads

129⁹⁹

H26-126
Mfg. #SC76



New In Duct Hot-wire Anemometer

- Measures air velocity and temperature in the duct with 38" telescoping probe
- Dual display for real-time display of CFM, air velocity or temperature
- Includes stabilizing cone and carrying case

259⁹⁹

H27-292
Mfg. #STA2



New Pocket Digital Psychrometer



- Real-time measurement of wet bulb, dry bulb, dew point and relative humidity
- Backlit dual display

49⁹⁹

H27-393
Mfg. #PRH2



New Micro CA-25 Inspection Camera



- Easily perform visual inspections in hard-to-reach areas
- 2.4" color LCD (234 x 480 resolution)
- 17mm camera head with 4 adjustable LEDs
- Cable reach of 3'
- Camera head and cable waterproof up to 10'

99⁹⁹

H27-401
Mfg. #40043



Psychrometer



- For precision measurement of temperature and humidity
- Dew point and wet bulb calculation
- Dual display

109⁹⁹

H25-451
Mfg. #THWD-3



Micro CA-100 Inspection Camera



- Easily perform visual inspections in hard-to-reach areas
- 3.5" color LCD (320 x 240 resolution)
- 17mm camera head with 4 adjustable LEDs
- Includes mirror, hook and magnet attachments

219⁹⁹

H85-609
Mfg. #36738



Cordless Pipe Clamp



- Can be used on pipes with diameters of 1/4" to 1-3/8"
- Includes retractable general purpose puncture probe
- Temperature range: -20° to +300°F

89⁹⁹

H26-325
Mfg. #40051J



Wireless Inspection Camera



- Detachable wireless color display can be viewed up to 32' from measurement point
- 3.5" display (320 x 240 pixels)
- 17mm camera head with 2 LEDs

199⁹⁹

H27-058
Mfg. #BR200



New Digital Thermometer



- Designed to hang or stand in refrigerator or freezer applications
- Temperature range: -22° to +122°F
- Accurate for life, no calibration necessary
- Water-resistant with anti-microbial additive

12⁹⁹

H27-420
Mfg. #2560J



Multi-Zone Temperature Testers



- Min/Max records highest and lowest temperature
- H26-079 adds humidity range: 10 to 95% RH

189⁹⁹

H26-078



Order #	Mfg. #	Description	Temp. Range	Price
H26-078	SH66AJ-E	3-Zone Temperature Tester	-40°F to +300°F	189.99
H26-079	SRH77AJ-E	3-Zone Temperature/Humidity Tester	-40°F to +300°F	269.99

Informant 2 Leak Detector



- Dual purpose refrigerant and combustible gas leak detector
- Refrigerant sensitivity: 0.25 oz. per year
- Combustible gas sensitivity: 50 PPM

309⁰⁰

H85-388
Mfg. #19-8038



Optimax Jr™ Ez-Ject™ Leak Detection Kit



- Dye injection, even into R410A systems
- POE/Universal dye cartridges treat multiple systems and are compatible with all refrigerants and lubricants

99⁹⁹

H26-479
Mfg. #OPK-50EZ/E



Optimax Jr™ Glo-Stick Leak Detection Kit



- Prefilled, disposable dye capsules eliminate measuring and pouring
- POE/Universal single-dose dye capsules are compatible with all refrigerants and lubricants

99⁹⁹

H27-004
Mfg. #OPK-50GS/E



TEK-Mate® Refrigerant Leak Detector



- 0.25 oz. per year sensitivity
- Automatic zeroing
- Variable-intensity audible signal and single flashing LED to pinpoint leaks

144⁹⁹

H25-784
Mfg. #705-202-G1



D-TEK Select Infrared Refrigerant Leak Detector



- 0.10 oz. per year sensitivity
- 800-hour sensor life, does not weaken over time
- Automatic zeroing

339⁰⁰

H85-436
Mfg. #712-202-G1



Refrigerant Leak Detector



- 0.05 oz. per year sensitivity
- Tri-color visual leak size indication
- Adjustable sensitivity and one touch reset

249⁹⁹

H26-232
Mfg. #TIFZX



New **Wireless Digital Manifold**



- Wireless enabled 4-port digital manifold with vacuum gauge
- Built-in P/T charts for 39 refrigerants
- Large temperature resistant LCD display
- Use optional H27-164 wireless transmitter to receive temperature measurements and superheat calculations
- Includes 2 pipe clamp probes, wet bulb/dry bulb thermocouples and storage pouch

449⁰⁰

H85-664
Mfg. #SMAN4



Digital Manifolds



- Fast and accurate diagnostics on all AC/R systems
- 2 temperature probe inputs for simultaneous real-time calculation of superheat and subcooling
- Large easy to read back-lit display
- All common refrigerants stored, eliminating the need for a separate P/T chart
- Robust housing protects the analyzer
- Includes carrying case and 2 pipe clamp probes



329⁰⁰
H85-592

Order #	Mfg. #	Description	Price
H85-592	0563-5506	550-2 2-Valve Digital Manifold Kit	329.00
H85-610	0563-5572	557 4-Valve Digital Manifold Kit w/ Vacuum Gauge	449.00
H85-659	0563-5703	570 4-Valve Digital Manifold w/ Vacuum Gauge and Data Storage	569.00

Add up to \$40 to every service call.
Install Novent® Locking Caps



- Compatible with all refrigerant tanks and service ports
- Helps eliminate leaks, theft, vandalism, inhaling opportunities and accidental refrigerant mixing
- Strongly supports EPA management programs
- Meets IMC (International Mechanical Code) 1101.10 and IRC (International residential Code) M1411.6 requiring locking caps on all outdoor service ports

Novent Keys

Order #	Mfg. #	Description	Price
B18-386	NC-KEY	Pocket Key for all Caps	7.99
B18-387	NC-GS	Screwdriver Key for R22 and Universal Caps	10.99
B18-388	NC-R	Screwdriver Key for R410A Caps	10.99



R22 Novent Cap

Order #	Mfg. #	Pack Size	Price
B18-371	NCG-4	4-Pack	19.99
B18-372	NCG-12	12-Pack	54.99
B18-373	NCG-50	50-Pack	199.99



R410A Novent Cap

Order #	Mfg. #	Pack Size	Price
B18-375	NCP-4	4-Pack	19.99
B18-376	NCP-12	12-Pack	54.99
B18-377	NCP-50	50-Pack	199.99



Universal Novent Cap

Order #	Mfg. #	Pack Size	Price
B18-381	NCU-4	4-Pack	19.99
B18-382	NCU-12	12-Pack	54.99
B18-383	NCU-50	50-Pack	199.99



R12/R22/R502 Manifold

- 2-valve, forged brass body
- Includes 36" red and blue hoses and 60" yellow hose
- 2-1/2" standard gauges

64⁹⁹

H24-579
Mfg. #M2-6

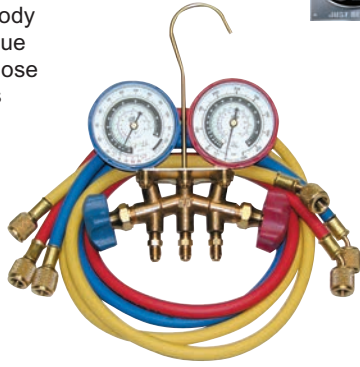

Zeppelin™ R22/R404A/R410A Manifold

- 4-valve, forged aluminum body
- Includes 3 60" hoses
- Large 3-1/8" glow-in-the-dark gauges

149⁹⁹

H85-505
Mfg. #25233



ZEPPELIN



Manifolds

Kobra Secure Seal Charging Hose Set

- UL recognized low loss fitting
- Rated for 800 PSI working pressure and 4,000 burst pressure
- Approved for R410A
- 60" length

59⁹⁹

B17-117
Mfg. #CCLS-60



New Revolver™ R22/R404A/R410A Manifold

- 4-valve, forged brass body
- Internal metering ball valves adjust to finite openings for liquid charging
- Includes 3 60" hoses
- Large 3-1/8" glow-in-the-dark gauges

169⁹⁹

H27-275
Mfg. #26233



R12/R22/R502 Manifold

- 2-valve, forged brass body
- Includes 3 60" hoses
- 2-1/2" standard gauges

62⁹⁹

H25-711
Mfg. #41215



R22/R407C/R410A Heat Pump Manifold

- 2-valve, forged brass body
- 2 800 PSI gauges for heat pump applications
- Includes 3 60" hoses
- Large 3-1/8" gauges

89⁹⁹

H27-156
Mfg. #42044



1/4" Charging Hose Set with Compact Ball Valve Fittings

- Full flow valve for faster recovery
- Approved for R410A
- 60" length

79⁹⁹

B13-534
Mfg. #29985

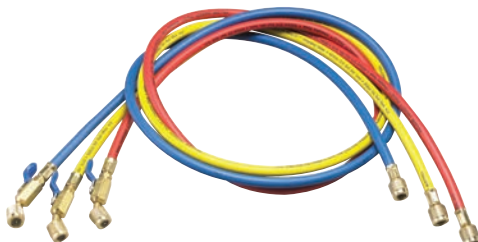

R22/R404A/R410A Manifold

- 4-valve, aluminum body
- Includes 4 60" hoses
- Large 3-1/8" gauges

159⁹⁹

H26-499
Mfg. #49967



Core Removal Tools

- Rated to hold 20 micron vacuum
- Double o-ring ball valve seal prevents leaks
- 1/4" side port for vacuum gauge attachment

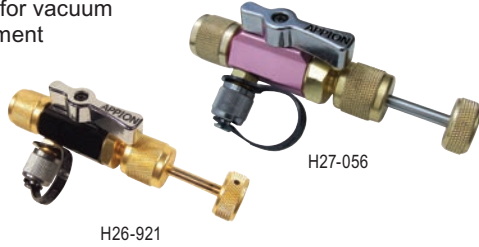
44⁹⁹

H26-921

H26-921

H27-056

Order #	Mfg. #	Description	Price
H26-921	MGAVCT	1/4" Vacuum Rated Valve Core Removal Tool	44.99
H27-056	MGAVCR	5/16" Vacuum Rated Valve Core Removal Tool	44.99

Digital Vacuum Gauge

- Digital display can show the vacuum in microns, PSI, milliBars, inches of Hg, Pascals, Torr and mTorr
- Measures vacuum from 12,000 to 0 microns

149⁹⁹

H26-062

Mfg. #VG64

5 CFM VacuMaster® Vacuum Pump

- 2-stage pump rated at 40 microns
- Compact and lightweight

174⁹⁹

H85-445

Mfg. #15500



6 CFM Eliminator Vacuum Pump

- Two-stage pump with 25 micron rating

289⁹⁹

H93-124

Mfg. #DV-6E



6 CFM Cool-Tech™ Vacuum Pump

- 2-stage pump rated at 15 microns
- Iso-Valve™ isolates pump from the system for accurate vacuum readings

329⁰⁰

H93-028

Mfg. #15600



7 CFM Platinum Series Vacuum Pump

- 2-stage pump rated at 15 microns
- Includes blank-off valve and check valve

399⁰⁰

H93-071

Mfg. #DV-200N



7CFM Bullet Vacuum Pump

- 2-stage pump rated at 25 microns
- Large brass oil drain for fast oil changes
- Wide mouth oil reservoir port for easier and cleaner filling

299⁹⁹

H85-596

Mfg. #93600



10 CFM Platinum Series Vacuum Pump

- 2-stage pump rated at 15 microns
- Includes blank-off valve and check valve

579⁰⁰

H93-072

Mfg. #DV-285N



Refrigerant Recovery Unit

PROMAX

- Recovers all CFC, HFC and HCFC refrigerants including R410A; liquid and vapor
- 28 lbs.

559⁰⁰

H93-131
Mfg. #RG6000



Refrigerant Recovery Unit

APPLION

- Recovers all common refrigerants including R410A liquid and vapor
- Twin cylinders and condensers provide fast recovery
- 2 to 4 times faster than most recovery units
- No purge required
- 24 lbs.

649⁰⁰

H93-103
Mfg. #G5 TWIN



New The Cube Refrigerant Recovery Unit

PROMAX

- Recovers R410A and all other common refrigerants, liquid and vapor
- Compact and lightweight for smaller jobs
- 18 lbs.

419⁰⁰

H93-171
Mfg. #RG3000



Refrigerant Recovery Unit

APPLION

- Recovers all common refrigerants including R410A liquid and vapor
- Outperforms larger machines in its class
- No purge required
- 22 lbs.

469⁰⁰

H93-129
Mfg. #G1 Single



Electronic Refrigerant Scale

TIF

- 110 lb. (50 kg) capacity
- Accuracy: $\pm 0.5\%$ of reading

134⁹⁹

H25-270
Mfg. #TIF9010A



Electronic Refrigerant Scale

CPS

- 220 lb. (100 kg) capacity
- Accuracy: $.015\%$ of reading

159⁹⁹

H26-215
Mfg. #CC220



R-22id Refrigerant Identifier

BACHARACH

- Quickly verifies the presence and quality of R22 refrigerant
- Displays a pass/fail reading based on 95% purity

629⁰⁰

H27-228
Mfg. #2100-8000



Wireless Refrigerant Scale

Fieldpiece

- Wireless handheld remote with backlight
- Remote stores within platform when not in use
- 220 lb. capacity

189⁹⁹

H26-914
Mfg. #SRS2C



Tube Cutters



- Won't "walk" while cutting
- Full-stop feed system prevents wheel damage
- Reamer and four roller tracking system on H26-508

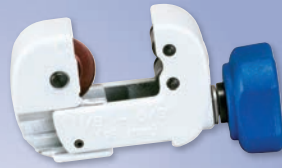

H26-505



H26-506



H26-507



H26-508

9⁹⁹

H26-505

Order #	Mfg. #	Description	Price
H26-505	21008TC58	1/8" to 5/8" Tube Cutter	9.99
H26-506	21009TC1	1/8" to 1" Tube Cutter	18.99
H26-507	21010TC118	1/8" to 1-1/8" Tube Cutter	20.99
H26-508	21011TC138	1/8" to 1-3/8" Tube Cutter	29.99

Swaging Tool

- Precision ground to size
- Expands 3/16", 1/4", 5/16", 3/8", 1/2" and 5/8" tube



10⁹⁹

H24-266
Mfg. #60460



Ratcheting Tube Bender

- One-handed bending tool for soft copper, aluminum and light wall hydraulic tubing
- Bends 1/4" to 7/8"
- Includes reamer and tube cutter



129⁹⁹

H85-528
Mfg. #60331



New Hydraulic Tube Expander Kit

- Expands 3/8" to 1-5/8" O.D. tubing with single hand operation
- Save time and money by eliminating fittings, soldering points and materials



319⁰⁰

H27-358
Mfg. #60493



Deluxe Flaring Tool

- Automatic tube height gauge
- Self-centering flaring yoke
- One-piece construction
- Full range: 1/8" to 3/4" O.D.



99⁹⁹

H26-428
Mfg. #60278



Braze-Rite Adapter

- Quickly connects to manifold gauge hose and slips easily and securely into pipe
- Allows for bleed of nitrogen through pipe being brazed to keep pipes clean and oxide-free



24⁹⁹

H26-966
Mfg. #BRZ1000



Self-Lighting Hand Torch

TurboTorch®

- For use with MAPP, MAP-Pro and propane
- 180° swivel tip
- Safety trigger switch

49⁹⁹

H24-391
Mfg. #SK-7000



New Air-Acetylene Tote Kit

TurboTorch®

- Complete kit for brazing and soldering projects
- Includes AR-B regulator, G-4 handle, PL-8A tip, A-3 tip, AH-12 hose and rolling tote

229⁹⁹

H85-656
Mfg. #TDLX2010B

*Tank not included



Portable Torch Kit

TurboTorch®

- Complete starter kit for soldering and brazing
- Includes self-lighting tips, torch handle, regulator, 12' hose, heat shield, solder and tool bag

169⁹⁹

H85-586
Mfg. #PL-DLXPT



*Gas cylinder not included

Air-Acetylene Torch Kit

TurboTorch®

- Self igniting
- Swirl combustion tip
- Includes regulator, hose, handle and tip

159⁹⁹

H85-307
Mfg. #PL-8ADLX-MC



New High Pressure Nitrogen Regulator

TurboTorch®

- 800 PSI delivery
- Forged brass body with zinc aluminum housing cap for added protection
- 1/4" flare fittings accept standard refrigeration hoses

99⁹⁹

H27-378
Mfg. #250-800-580



Nitrogen Regulator



- Forged brass body
- 1/4" flare outlet fittings
- Fits all nitrogen tanks

39⁹⁹

H26-212
Mfg. #RHP400

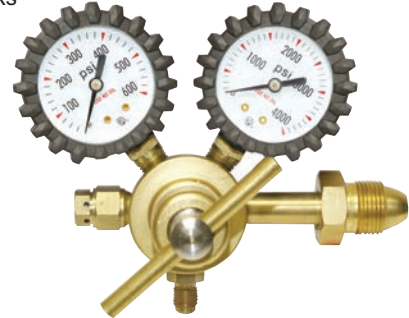

Nitrogen Purge Kit

TurboTorch®

- A complete kit to pressure check and purge lines before brazing
- Includes nitrogen regulator, turbo tornado, 1/2" cone plug, 3/4" cone plug, needle tip, CO2 adapter, 36" x 1/4" hose, 72" x 1/4" hose and blow gun

149⁹⁹

H85-585
Mfg. #NPK-TT



Nitrogen Flowmeter



- While brazing, a float ball indicates low nitrogen pressure when purging copper lines
- Attaches directly to any nitrogen regulator with a 1/4" male outlet fitting

39⁹⁹

H26-625
Mfg. #UNF3



Serrated Duct Knife



- Double-edged knife with regular and serrated edges
- 5-1/2" blade cuts duct board and flexible duct
- Includes nylon sheath with belt loop

11⁹⁹

H27-088
Mfg. #DK06



PVC Cutter



- Cuts up to 3/4" PVC and 1-3/8" flexible plastic pipe
- Makes clean burr-free cuts
- Steel handle construction for added strength

11⁹⁹

H26-923
Mfg. #50506



New One-Handed Ratcheting PVC and Tubing Cutter



- Cuts PVC, PE, PEX and ABS pipe
- All metal construction for greater durability
- Extended handles for added leverage
- Locking strap keeps blade concealed for safe storage
- Capacity: 1-5/8"

12⁹⁹

H27-490
Mfg. #1191



PowerLock Multi-Tool



- Exclusive gear-driven compound leverage
- 1-handed flip opening and closing
- 100% stainless steel construction
- Includes nylon pouch
- Lifetime warranty

54⁹⁹

H26-984
Mfg. #S62-N



Reciprocating Blades



- Choose from assorted lengths and blade types

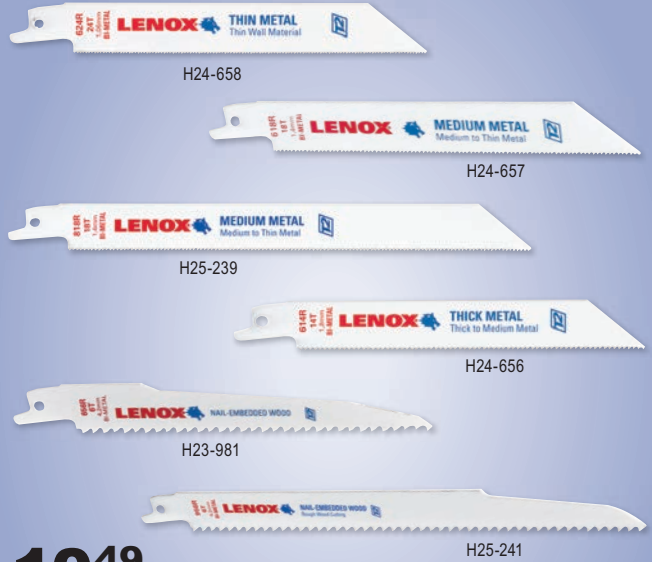

10⁴⁹
H24-658

Order #	Mfg. #	Length	Description	Price
H24-658	20568624R	6"	Metal Pipe 18 ga. and under	10.49
H24-657	20566618R	6"	Metal 1/8" to 1/4" Conduit	10.49
H25-239	20578818R	8"	Metal 1/8" to 1/4", Conduit	12.99
H24-656	20564614R	6"	Metal 1/4" to 1/2"	10.49
H23-981	20572656R	6"	Rough-in Work in Wood	12.49
H25-241	20582956R	9"	Rough-in Work in Wood	15.99

Vari-Bit Step Drill Bits



- Steps make hole size identification easy
- Double flute design cuts burr-free holes
- Drills metals up to 1/8" thick



29⁹⁹
H24-872

Order #	Mfg. #	Description	Size	Price
H24-872	VB3	9 Step Vari-Bit	1/4" to 3/4"	29.99
H26-333	VB2	9 Step Vari-Bit	1/2" to 1"	34.99
H24-873	VB11	2 Step Vari-Bit	7/8" to 1-1/8"	44.99
H24-874	VB12	5 Step Vari-Bit	7/8" to 1-3/8"	49.99

Cordless Precision Engraver



- Strong diamond tip bit for marking tools and other valuables
- Use on metal, plastic, ceramic or glass surfaces



11⁹⁹
H27-207
Mfg. #505

5-Piece Screwdriver Set



- 3/16" and 1/4" cabinet, 1/4" and 5/16" keystone, #2 Phillips
- Cushion grip handles

34⁹⁹

H25-280
Mfg. #85075



New Demolition Drivers



- Heat treated metal shaft runs complete length of handle to metal strike cap to transfer metal strike force
- Plated metal strike cap to protect handle from hammer blows

11⁹⁹

H27-437

H27-437

H27-438



Order #	Mfg. #	Description	Overall Length	Price
H27-437	602-4DD	1/4" Slotted Keystone Tip	9"	11.99
H27-438	602-7DD	5/16" Slotted Keystone Tip	12"	14.99

Terminal Block Screwdriver



- Precision machined tip provides exact fit for terminal block screws
- Cushion grip handle

5⁹⁹

H27-224
Mfg. #612-4



Screw-Holding Screwdrivers



- Starts and drives screws with 1 hand when working in hard-to-reach spaces
- Cushion grip handle

6⁴⁹

H27-218

H27-218

H27-219



Order #	Mfg. #	Description	Overall Length	Price
H27-218	32215	1/4" Flat Tip	11-1/4"	6.49
H27-219	32216	#2 Phillips Tip	11-1/4"	6.49

Ratcheting 10-in-1 Screwdriver/Nut Driver



- 3-way ratcheting mechanism with forward, reverse and locked positions
- Includes 3/16" and 1/4" slotted, #1 and #2 Phillips, 1/4", 5/16", and 3/8" nut drivers, #1 and #2 square-recess and 3/8" hex driver
- Cushion grip handle

17⁹⁹

H27-220
Mfg. #32558



Stubby 6-in-1 Screwdriver/Nut Driver



- Compact design allows easy access to tight work spaces
- Includes 3/16" and 1/4" slotted, #1 and #2 Phillips, 1/4" and 5/16" nut drivers
- Cushion grip handle

8⁹⁹

H27-222
Mfg. #32561



Magnetic Hex Drivers



- 1/4" hex shank with quick release groove
- Strong rare earth magnets for maximum holding

5⁴⁹

H27-097



H27-097



H27-098



H27-099

Order #	Mfg. #	Hex Opening	Length	Price
H27-097	86600	1/4"	1-3/4"	5.49
H27-098	86601	5/16"	1-3/4"	5.49
H27-099	86602	3/8"	1-3/4"	5.49

2-Piece Magnetic Tip Nut Driver Sets



- 1/4" and 5/16"
- Hollow shaft for long bolts or studs
- Cushion grip handles

14⁹⁹

H26-313



Order #	Mfg. #	Overall Length	Price
H26-313	610M	3-1/2"	14.99
H26-314	630M	6-3/4"	14.99
H26-315	646M	9-3/4"	16.99



170-Piece Professional Tool Set

- Includes standard and deep sockets, wrenches, pliers, screwdrivers, hex keys and more
- Quick-release ratcheting drives
- Folding case for easy storage

99⁹⁹

H85-517
Mfg. #CTK170MP



Wide Opening Adjustable Wrenches

- Non-slip cushion grip
- Wide handle for greater comfort and reduced fatigue

14⁹⁹

H26-928



Order #	Mfg. #	Size	Capacity	Price
H26-928	AC14CV	4"	1/2"	14.99
H26-929	AC16CV	6"	15/16"	14.99
H26-930	AC18CV	8"	1-1/8"	15.99
H26-931	AC110CV	10"	1-5/16"	18.99
H26-932	AC112CV	12"	1-1/2"	26.99

7-Piece Reversible Ratcheting Combination Wrench Set

- Rapid reverse with the push of a button
- Includes 3/8", 7/16", 1/2", 9/16", 5/8", 11/16" and 3/4"

59⁹⁹

H85-372
Mfg. #9567RN



7-Piece 180° Pivot Head Ratcheting Combination Wrench Set

- Ratcheting box end pivots a full 180° allowing maximum leverage
- Includes 3/8", 7/16", 1/2", 9/16", 5/8", 11/16" and 3/4"

72⁹⁹

H26-266
Mfg. #9700



Alligator Pliers

- Self-gripping on pipes and nuts
- 7-position adjustment

17⁹⁹

H24-808



Order #	Mfg. #	Size	Capacity	Price
H24-808	8801250SBA	10"	1/8" to 2"	17.99
H24-809	8801300SBA	12"	1/8" to 2-3/4"	26.99
H26-893	002007US1	Set of 7", 10" & 12"	1/8" to 2-3/4"	59.99

Cobra Pliers

- Self-gripping on pipes and nuts
- Push button action for one-handed adjustment

23⁹⁹

H25-786



Order #	Mfg. #	Size	Capacity	Price
H25-786	8701180SBA	7"	1/8" to 1-1/2"	23.99
H25-787	8701250SBA	10"	1/8" to 2"	24.99
H25-788	8701300SBA	12"	1/8" to 2-3/4"	34.99

Plier Wrenches

- Box joint construction and ergonomic design
- 13 position push button
- Unique cam action ratcheting system for speed and leverage

39⁹⁹

H25-789



Order #	Mfg. #	Size	Capacity	Price
H25-789	8603180SBA	7"	Up to 1-3/8" Hex	39.99
H25-790	8603250SBA	10"	Up to 1-3/4" Hex	44.99

Magnetic LED Tool Light

- Built-in magnet attaches to pliers or other tools to illuminate the work area
- Up to 24 hours runtime
- Includes snap hook for attaching to keychain
- Powered by 2 CR1220 batteries (included)

9⁹⁹

H27-484
Mfg. #0011V50



*Pliers pictured not included

Standard Aviation Snips

MIDWEST
TOOLS

- Forged steel blades
- Full length "Pinch-to-Point" cut



H24-225



H24-226



H24-227

12⁹⁹

H24-225

Order #	Mfg. #	Cut Type	Cut Length	Price
H24-225	MW-P6716L	Left	1-3/8"	12.99
H24-226	MW-P6716R	Right	1-3/8"	12.99
H24-227	MW-P6716S	Straight	1-1/2"	12.99

Offset Aviation Snips

MIDWEST
TOOLS

- Forged steel blades
- Full length "Pinch-to-Point" cut



H24-508



H24-509

15⁹⁹

H24-508

Order #	Mfg. #	Cut Type	Cut Length	Price
H24-508	MW-P6510L	Left	1-1/4"	15.99
H24-509	MW-P6510R	Right	1-1/4"	15.99



High-Leverage Side-Cutting Lineman's Pliers

KLEIN TOOLS
For Professionals... Since 1857™

- High leverage design for 46% greater cutting power
- Hot-riveted joint for smooth action and no handle wobble

24⁹⁹

H25-276

Mfg. #D213-9NE



Long Nose All-Purpose Tool

KLEIN TOOLS
For Professionals... Since 1857™

- Crimps insulated and non-insulated connectors from 10 to 22 AWG
- Cutters for 4-40, 5-40, 6-32, 8-32, 10-32 and 10-24 bolts
- Strips gauges 10, 12, 14 and 16 solid wire

16⁹⁹

H25-934

Mfg. #1010

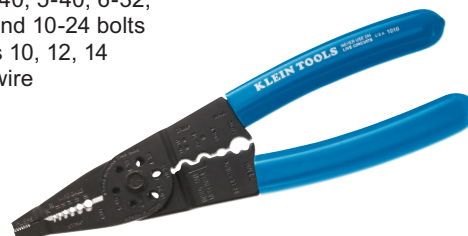

Crimping/Cutting Tool

KLEIN TOOLS
For Professionals... Since 1857™

- Tapered nose design for working in confined spaces
- Specially hardened cutter

29⁹⁹

H26-275

Mfg. #J1005



Wire Stripper/Cutters

KLEIN TOOLS
For Professionals... Since 1857™

- Strips solid wire and stranded wire
- Hardened steel with precision-ground stripping holes
- 8-32 and 6-32 screw-shearing holes

15⁹⁹

H26-267

Mfg. #11055



New **Power Assisted Crimper** *Malco*

- Easily and quickly crimp large diameter duct and multiple smaller duct runs
- Inserts into chuck of 14.4V (minimum) cordless or 7A (maximum) corded drill

179⁹⁹
H85-712
Mfg. #C5A



REDLINE™ Crimpers *Malco*

- Ergonomically contoured non-slip handles
- Latch allows for easy open and close

29⁹⁹
H26-878



Order #	Mfg. #	Description	Price
H26-878	SC3R	3-Blade Crimper	29.99
H26-879	C5R	5-Blade Crimper	26.99

TurboShear *Malco*

- Turn your drill into a power shear
- Attaches to any standard 1,200 RPM corded or cordless drill with 3/8" or larger chuck
- 20 gauge sheet metal capacity

39⁹⁹
H26-198
Mfg. #TS1



REDLINE™ Hand Seamers *Malco*

- Ergonomically contoured non-slip handles
- Scaled depth marks on jaws are in 1/4" increments for precise depth bends

39⁹⁹
H26-875



Order #	Mfg. #	Description	Price
H26-875	S2R	3-1/4" Hand Seamer	39.99
H26-876	S3R	3-1/4" Offset Hand Seamer	42.99
H26-877	S6R	6" Hand Seamer	54.99

Sheet Metal Hole Cutters *Malco*

- 20 gauge capacity
- Installs on standard electric drill
- H25-659 cuts 2" to 12" diameter
- H25-884 cuts 2" to 20" diameter

49⁹⁹
H25-659



Order #	Mfg. #	Description	Price
H25-659	HC1	Original Hole Cutter	49.99
H25-884	HC2	Large Hole Cutter	64.99

Tensioning Tool *Malco*

- Attaches nylon ties to flex duct and sheet metal take-offs
- Works on all ties including thin designs

29⁹⁹
H24-583
Mfg. #TY4G



Folding Tools *Malco*

- Fold 24 to 30 gauge sheet metal

10⁹⁹
H25-171



Order #	Mfg. #	Length	Price
H25-171	12F	12"	10.99
H25-170	18F	18"	14.99

48-Pocket Tool Backpack



- 41 inside and 7 outside pockets
- Large pads on back for extra comfort
- Reinforced padded carrying handles

59⁹⁹

H85-636
Mfg. #1134



*Tools pictured not included

Open-Top Soft-Sided Tool Carrier



- 21 multi-use pockets and 10 webbing loops
- Sturdy metal handle with molded foam grip
- 14" L x 11" W x 11" H

29⁹⁹

H85-510
Mfg. #1578



*Tools pictured not included

43-Pocket Tool Carrier



- 2 window pockets, 1 removable and 1 stationary, for easy view of contents
- 7" x 5-1/2" multi-compartment plastic tray included
- 23"L x 12"W x 15"H

39⁹⁹

H85-424
Mfg. #1530



*Tools pictured not included

3-Piece Nylon Rain Suit



- Jacket, elastic pants and detachable hood
- Full cut sizes to fit over clothing
- Storm front jacket with zippered closure



26⁹⁹

W69-456

Order #	Mfg. #	Size	Price
W69-456	R103M	Medium	26.99
W69-457	R103L	Large	26.99
W69-458	R103X	Extra Large	26.99
W69-471	R1032X	2X Large	26.99

Contractor XC Gloves



- Reinforced palm for added abrasion resistance and better grip
- Padded fingers and knuckles for protection
- Full neoprene cuff



14⁹⁹

W69-297

Order #	Mfg. #	Size	Price
W69-297	160M	Medium	14.99
W69-298	160L	Large	14.99
W69-299	160XL	Extra Large	14.99

Gel-Tek™ Stabili-Cap™ Kneepads



- Stabili-Cap™ design provides a solid kneeling base and allows for easier forward movement, effectively increasing your range of motion



29⁹⁹

W69-446
Mfg. #376

Tradesman Gloves



- Padded palm, fingers and knuckles
- Flex-Spot™ thumb design for better flexibility
- Full neoprene cuff



15⁹⁹

W69-300

Order #	Mfg. #	Size	Price
W69-300	145M	Medium	15.99
W69-301	145L	Large	15.99
W69-302	145X	Extra Large	15.99

Kneeling Pad



- Excellent shock absorption and cushioning
- Silicone-free material will not degrade with oil or petroleum contact
- 21" L x 14" W x 1" H



14⁹⁹

W89-883
Mfg. #302

LightStar80 LED Penlights



- 80 lumen output
- High CRI LED for superior color rendering
- Available in grey or high visibility orange



16⁹⁹
G35-928

Order #	Mfg. #	Price
G35-928	TLF-802AAA-BK	16.99
G35-929	TLF-802AAA-OR	16.99

LightStar300 LED Flashlights



- Dual mode (300 or 100 lumen output)
- Available in grey or high visibility orange



29⁹⁹
G35-865

Order #	Mfg. #	Price
G35-865	TLF-3002AA-BK	29.99
G35-927	TLF-3002AA-OR	29.99

WorkStar80 Rechargeable Work Light



- Super bright, cordless trouble light
- Combination 64 LED work light (4-hour run time) and 16 LED flashlight (12-hour run time)
- Includes AC and DC chargers
- Recharges in 90 minutes



32⁹⁹
G80-534
Mfg. #TLW-80

New InfiniStarCR Rechargeable LED Flashlight



- 300 lumen output
- Single mode, momentary switch
- Up to 2-hours runtime
- Aircraft grade aluminum
- Water-resistant
- Includes rechargeable batteries and AC charger



89⁹⁹
G36-472
Mfg. #TLF-NFSTC-OR

Extendable Magnetic Flashlight with Mirror



- 3 bright LEDs
- Magnet on both ends for use as a magnetic pickup tool
- Extends from 6-1/2" to 21"
- Flexible shaft for hard-to-reach places



16⁹⁹
G36-253
Mfg. #EMF-2

New Inspection Mirrors



- Double ball joints adjust to any angle
- Choose from round or rectangular styles



7⁹⁹
H27-487

Order #	Mfg. #	Description	Price
H27-487	80557	2" Round Telescoping Inspection Mirror w/ LED Lights	7.99
H27-094	80560	2" x 3" Rectangular Telescoping Inspection Mirror w/ LED Lights	7.99

New Lighted Magnetic Torpedo Level



- Lights up for maximum visibility
- 10-minute auto shut-off saves battery life
- Top-read level window simplifies viewing in tight areas
- V-grooved edge for pipe and conduit work



35⁹⁹
H27-288
Mfg. #9330RE

Lighted Mechanical Pick-Up Tool



- Easily retrieve items from hard-to-reach areas
- 24" LED illuminates area when retrieval claw is used
- Flexible shaft to avoid obstacles

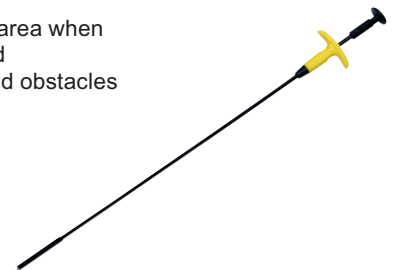

7⁹⁹
H27-205
Mfg. #70396

Industrial Batteries

Energizer
INDUSTRIAL

- Alkaline batteries designed for heavy current or continuous use applications



G22-302



G21-865



G22-719



G21-864



G21-863

45¢

G22-302

Order #	Mfg. #	Description	Price
G22-302	EN92	AAA Industrial Alkaline	0.45
G21-865	EN91	AA Industrial Alkaline	0.39
G22-719	EN22	9V Industrial Alkaline	1.39
G21-864	EN93	C Industrial Alkaline	0.79
G21-863	EN95	D Industrial Alkaline	0.99

LED Headlamp

Energizer



- 6 LED headlight with 2 white spots, 2 white floods and 2 red night vision lights
- Up to 50 hour run time on three AAA batteries

13⁹⁹

G33-170
Mfg. #HDL33AINE



New Lithium Batteries

Energizer

- Lighter and longer lasting than alkaline batteries
- Up to 10 year shelf life
- Works in temperatures -40°F to +140°F



G36-482



G36-483

1⁹⁹

G36-482

Order #	Mfg. #	Description	Price
G36-482	L91	AA Lithium Battery	1.99
G36-483	LA522	9V Lithium Battery	5.99

CoilJet Portable Coil Cleaning System

SPEEDCLEAN

- Specifically designed for condenser and evaporator coil cleaning
- No hose or electrical connection required
- Powerful 125 PSI spray will efficiently clean both sides of condenser and evaporator coil
- Angled adapters and wands sold separately

449⁰⁰

W89-766
Mfg. #CJ-125



Bucket Descaler

SPEEDCLEAN

- Eliminates limescale and other deposits from tankless and standard water heaters
- Simply attach to water in/out and circulate with descaler
- Includes bucket, 2 hoses and powerhead assembly

249⁹⁹

W89-881
Mfg. #SC-DS-5



Condenser Needle

SPEEDCLEAN

- Turn any garden hose into a powerful condenser cleaning tool
- Unique 3+ gallons per minute spray nozzle will not damage delicate fins
- Adjustable chemical injection valve

119⁹⁹

X82-258
Mfg. #CN-03

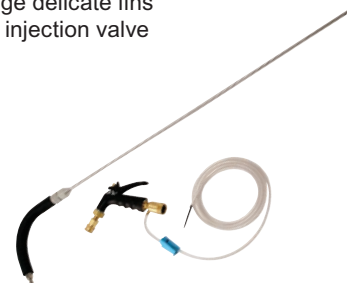

R22/R404A/R410A Manifold

- 2-valve, forged brass body
- Includes 3 60" hoses
- 2-1/2" standard gauges

74⁹⁹

 H26-733
 Mfg. #M2-5-410A

TAKE US WITH YOU!
Mobile App and Toolkit for
Apple and Android.

 Visit www.JohnstoneSupply.com today.

Be the Go-To HVACR Pro with FLIR infrared.

Still using an IR thermometer for temperature readings? With an infrared camera from FLIR, simply point at the target and see the temperature in seconds! Never miss a malfunctioning compressor, missing insulation or a leaking duct again. So affordable, you can add one to your tool bag today!

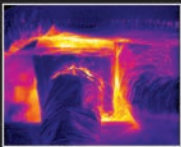

Heating Ducts



Failed Steam Traps



FLIR i7
H27-007
1,995

FLIR E40
H85-649
3,995



Quality - Innovation - Trust

 For more information, visit www.JohnstoneSupply.com